

# CW-16H1A454 (Primary)

## CX-16H1A454 (Link)

The Server Technology® Switched PDU provides control of outlet power and local LED input current monitoring, allowing IT personnel to determine safe levels of loading on a per-phase basis while installing equipment into the rack/cabinet. The integral PIPS® technology provides accurate measurement of current (billing-grade), voltage, active power, apparent power, power factor, crest factor, and accumulated energy at the input. These power data points, along with temperature and humidity measurements (provided via optional probes), are accessible through the built-in Web and CLI interfaces as well as through SNMP. The Switched "Primary" PDU can be connected to a Switched "Link" PDU to extend the network access to the redundant or secondary power feed.

## Key Features



### Network Monitoring

Gain access to valuable data through connections including HTTP(S), SSH, Telnet, SNMP, (S)FTP, SMTP, Syslog, LDAP(S), RS-232 serial, and more.



### Temperature/Humidity Monitoring

Primary and Expansion (select products) units each support two external 10' (3m) T/H probes. Receive SNMP-based alerts and email notifications.



### Per-Inlet Power Sensing

PIPS® (Per Inlet Power Sensing) Monitors Current Load (A), Voltage (V), Power (W), Apparent Power (VA), Crest Factor, Power Factor, & Energy per inlet.



### Outlet Control

On Switched PDUs, cycle power to individual outlets or groups of outlets to reboot servers, or power off unused receptacles.



### Hot-Swap Network Card

Network access is ensured when power is lost to the Primary unit with backup power provided by the Linked unit.



### Auto-Flip Current Display

Easy-to-read LEDs display current per phase to help prevent overloads and simplify three-phase load balancing in high-density cabinets.



### Branch Circuit Protection

This PDU meets the UL and IEC 62368-1 requirement for branch circuit protection through UL 489 rated magnetic-hydraulic circuit breakers or UL 248 fuses.



### Color-Coded Options

Select from six colors to designate PDU circuits in the data center — black, white, red, green, blue, and yellow.

## Inputs

Input Voltage (V):	120
Frequency	50/60 Hz
Input Plug:	IEC C20 100-120V Inlet
Input Current (A):	20
Input Current Rated (A):	16
Input Power Capacity (kW):	1.9
<i>Requires PTCORD-L5, -L6, or -L7</i>	

## Outputs

Connector	Rating
(16) x NEMA 5-20R	North American Rating: $\leq 16A @ 120V L-N$ (20A Peak)

## Branch Circuit Protection

UL 489, CSA C22.2 No. 5 & IEC/EN 60947-2 Compliant 1-pole, 20A trip circuit breakers, two (2) branch, rating:  $\leq 16A$ , 5 kAIC Interrupt Rating

## Physical

Dimensions: 3.5in tall x 17.2in wide x 7.1in deep [89mm x 437mm x 181mm]

## Environmental

**Operating Environment:** 32°F to 122°F / 0°C to 50°C | 8%RH to 90%RH non-condensing | 6,500ft/2km elevation

**Storage Environment:** -22°F to 176°F / -30°C to 80°C | 8%RH to 90%RH non-condensing | 50,000ft/15km elevation

**Quiescent / Unloaded Power Draw:** < 10W for all configurations

## Communications & Security

10/100 Mbps Ethernet (RJ-45 connector), RS-232 serial (RJ-45 connector)

Two (2) temperature/humidity sensor inputs (4P4C), Link port (RJ-12) - {also on Link PDU}

Web-browser GUI and command-line interface (CLI): HTTP/HTTPS, TLSv1.2, SSHv2, Telnet, SNMPv2c and v3 (GET, SET, Traps), IPv4 and IPv6, LDAPv3/LDAPS, TACACS+, RADIUS, FTP/SFTP

## Certifications

### North American:

Safety (Listed & Certified, cTUVus mark)

UL 62368-1

CSA C22.2 No. 62368-1

EMC

FCC Part 15 Subpart B Sections 15.107 & 15.109, Class A

CAN ICES-003, Class A

## Measurement Accuracy

### Input Measurement Accuracy:

LED Current =  $\pm 10\%$  at 0.1 amp (0.3 - 9.9 amps) and 1 amp (> 9.9 amps) resolution

GUI Current =  $\pm 1\%$  at 0.01 amp resolution (above 0.25 amp)

Voltage =  $\pm 1\%$  at 0.1 volt resolution (nominal  $\pm 10\%$ )

Active Power =  $\pm 1\%$  at 1 watt resolution

Apparent Power =  $\pm 1\%$  at 1 volt-amp resolution

Power Factor =  $\pm 3\%$  at 0.01 resolution

Crest Factor =  $\pm 10\%$  at 0.1 resolution

Energy =  $\pm 1\%$  at 0.1 kilowatt-hour resolution

## Optional Accessories

EMTH-2-10 Combination Temperature/Humidity Probe, 10ft (3m)

EMCU-1-1C Environmental Monitor adding:

- Two (2) EMTH-2-10 temperature/humidity ports (one probe included)
- One (1) EMWS-1-1 water sensor port (probe sold separately)
- Four (4) dry contact (NO/NC) monitoring points
- One (1) 8-bit analog-to-digital converter (0 to 5VDC)

KIT-SUS-01 StartUp Stick™ for rapid configuration Mounting Brackets

- mounting brackets included
- See the Mounting Bracket Guide for further suggestions
- Custom mounting options available. Contact your local Server Technology representative

Cable Retention Devices for non-locking cords

- EZip
- Cable Sleeve

# Drawings

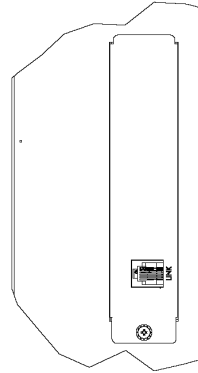
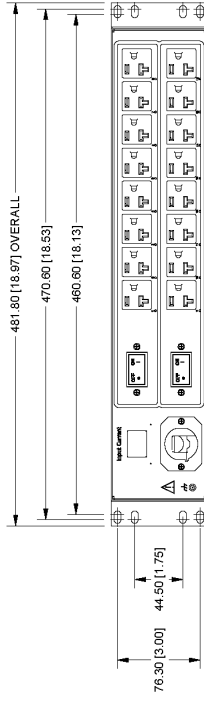
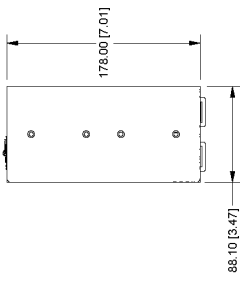
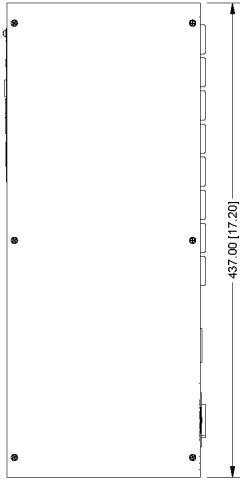
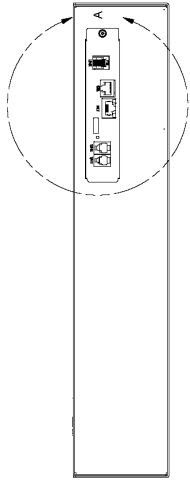

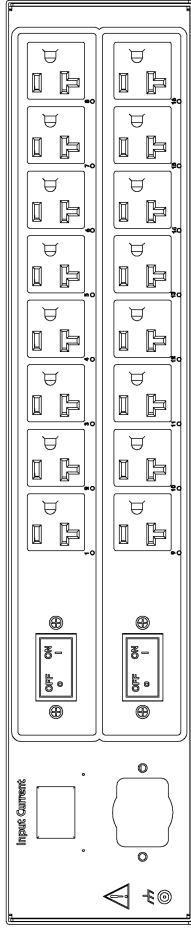
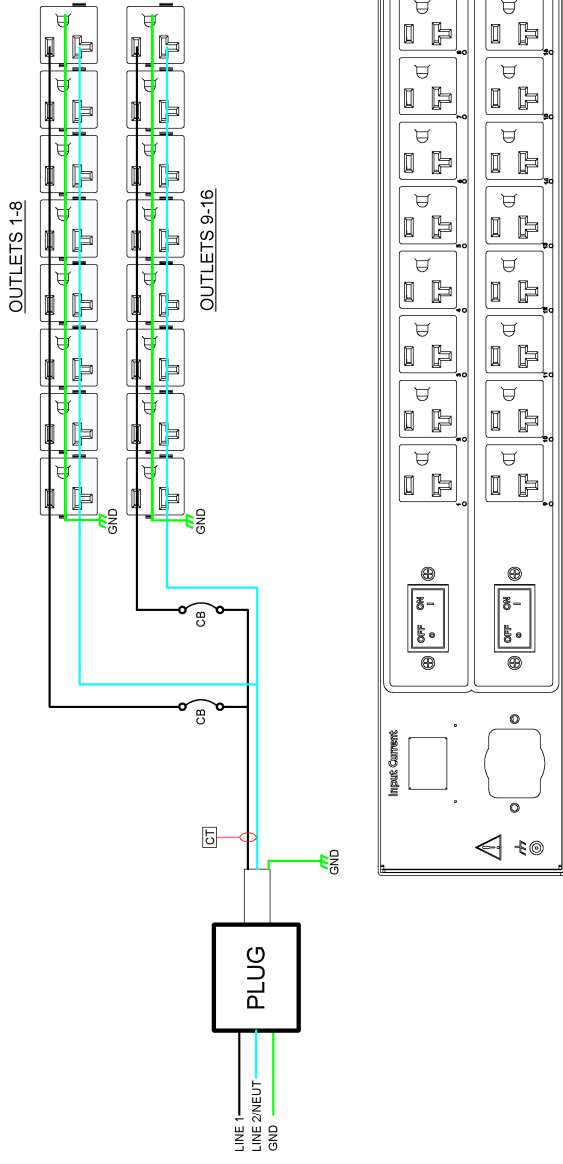

## Additional Information

**Warranty:** Server Technology offers a standard 2-year limited parts & labor warranty. Extended support is available at the time of purchase. See the Support Options on the website, or contact your local Server Technology representative for more information.

**Patents:** Information on Server Technology patents is available on the website at: [www.servertech.com/products/patents](http://www.servertech.com/products/patents)

"Global" models are typically for use in countries outside of North America. Contact your Server Technology representative for more information about which models are appropriate for your application.

Information in this document is current as of time of publishing. Contact your Server Technology representative for the most up-to-date information. This datasheet was generated on: 17-May-2025

Interested in learning more about how Server Technology can help you manage and distribute power in your datacenter?  
Visit us online at: [www.servertech.com/products/](http://www.servertech.com/products/)

To contact an expert in your region, go to [www.servertech.com/about-us/office-locations](http://www.servertech.com/about-us/office-locations) for more information.

servertech.com ©2025 Legrand. All rights reserved. The industry-leading brands of Raritan, Server Technology, Starline, and Ortronics empower Legrand's Data, Power & Control to deliver innovative solutions for data centers, building networks, and facility infrastructures.