

C2S24HP-YBLN5D6 (Primary)

C2L24HP-YBLN5D6 (Link)

The Server Technology® PRO2 Smart PDU provides local LED input current monitoring, allowing IT personnel to determine safe levels of loading on a per-phase basis while installing equipment into the rack/cabinet. The integral PIPS® technology provides billing-grade accurate measurement of current, voltage, active power, apparent power, power factor, crest factor, and accumulated energy at the input. These power data points, along with temperature and humidity measurements (provided via optional probes), are accessible through the built-in Web and CLI interfaces as well as through SNMP. The PRO2 Smart “Primary” PDU can be connected to as many as three (with optional module) PRO2 Smart “Link” PDU to extend the network access to the redundant or secondary power feed without the risks of a daisy chain linking configuration.

Key Features



Network Monitoring

Gain access to valuable data through connections including HTTP(S), SSH, Telnet, SNMP, (S)FTP, SMTP, Syslog, LDAP(S), RS-232 serial, and more.



Star Multi-Linking

PRO2 provides the ability to link up to four power circuits using one IP address. Primary Expansion PDU provides backup power to network card.



Auto-Flip Current Display

Easy-to-read LEDs display current per phase to help prevent overloads and simplify three-phase load balancing in high-density cabinets.



Branch Current Monitoring

Monitors current at each breaker branch and provides SNMP-based alerts and emails on high usage that risks a tripped circuit.



Alternating-Phase Outlets

Evenly distributes multiple phases of power to each outlet for simplified load balancing, reduced cord lengths, and better airflow.



High Temperature Rating

This product has been tested and approved for safe and reliable operation in 60 °C data center environments.



Hot-Swap Network Card

Network access is ensured when power is lost to the Primary unit with backup power provided by the Linked unit.



Temperature/Humidity Monitoring

Primary and Expansion (select products) units each support two external 10' (3m) T/H probes. Receive SNMP-based alerts and email notifications.



Per-Inlet Power Sensing

PIPS® (Per Inlet Power Sensing) Monitors Current Load (A), Voltage (V), Power (W), Apparent Power (VA), Crest Factor, Power Factor, & Energy per inlet.



Branch Circuit Protection

This PDU meets the UL and IEC 62368-1 requirement for branch circuit protection through UL 489 rated magnetic-hydraulic circuit breakers or UL 248 fuses.



HDOT (High Density Outlet Technology)

The highest outlet density available in a network connected PDU. Meets IEC C13 and C19 specifications, plus high native retention, and UL94V-0 flame rating.



Color-Coded Options

Select from six colors to designate PDU circuits in the data center — black, white, red, green, blue, and yellow.

Inputs

| | |
|----------------------------|--------------|
| Input Voltage (V): | 208 |
| Frequency | 50/60 Hz |
| Input Plug: | NEMA L21-20P |
| Input Current (A): | 20 |
| Input Current Rated (A): | 16 |
| Input Power Capacity (kW): | 5.7 |

Outputs

| Connector | Rating |
|----------------------|--|
| (18) x IEC 60320/C13 | North American Rating: $\leq 12A @208V$ L-L (15A Peak) |
| (6) x IEC 60320/C19 | North American Rating: $\leq 16A @208V$ L-L (20A Peak) |

Branch Circuit Protection

UL 489, CSA C22.2 No. 5 & IEC/EN 60947-2 Compliant 2-pole, 20A trip circuit breakers, three (3) branch, rating: $\leq 16A$, 5 kAIC Interrupt Rating

Physical

Dimensions: 3.5in tall x 17.2in wide x 10.0in deep [89mm x 437mm x 254mm]

Environmental

Operating Environment: 32°F to 140°F / 0°C to 60°C | 8%RH to 90%RH non-condensing | 6,500ft/2km elevation

Storage Environment: -22°F to 176°F / -30°C to 80°C | 8%RH to 90%RH non-condensing | 50,000ft/15km elevation

Quiescent / Unloaded Power Draw: < 10W for all configurations

Communications & Security

10/100/1000 Mbps Ethernet (RJ-45 connector), RS-232 serial (RJ-45 connector)

Two (2) temperature/humidity sensor inputs (4P4C), Link port (RJ-12) - {also on Link PDU}

Web-browser GUI and command-line interface (CLI): HTTP/HTTPS, TLSv1.2, SSHv2, Telnet, SNMPv2c and v3 (GET, SET, Traps), IPv4 and IPv6, LDAPv3/LDAPS, TACACS+, RADIUS, FTP/SFTP

Certifications

North American:

Safety (Listed & Certified, cTUVus mark)

UL 62368-1

CSA C22.2 No. 62368-1

EMC

FCC Part 15 Subpart B Sections 15.107 & 15.109, Class A

CAN ICES-003, Class A

Measurement Accuracy

Input Measurement Accuracy:

LED Current = $\pm 10\%$ at 0.1 amp (0.3 - 9.9 amps) and 1 amp (> 9.9 amps) resolution

GUI Current = $\pm 1\%$ at 0.01 amp resolution (above 0.25 amp)

Voltage = $\pm 1\%$ at 0.1 volt resolution (nominal $\pm 10\%$)

Active Power = $\pm 1\%$ at 1 watt resolution

Apparent Power = $\pm 1\%$ at 1 volt-amp resolution

Power Factor = $\pm 3\%$ at 0.01 resolution

Crest Factor = $\pm 10\%$ at 0.1 resolution

Energy = $\pm 1\%$ at 0.1 kilowatt-hour resolution

Branch Measurement Accuracy

Current = $\pm 3\%$ at 0.01 amp resolution (above 0.5 amp)

Optional Accessories

EMTH-2-10 Combination Temperature/Humidity Probe, 10ft (3m)

EMCU-1-1C Environmental Monitor adding:

- Two (2) EMTH-2-10 temperature/humidity ports (one probe included)

- One (1) EMWS-1-1 water sensor port (probe sold separately)

- Four (4) dry contact (NO/NC) monitoring points

- One (1) 8-bit analog-to-digital converter (0 to 5VDC)

KIT-PRO2LINK-01M or -01D provides ability to link (2) additional PRO2 units

KIT-SUS-01 StartUp Stick™ for rapid configuration

- mounting brackets included

- See the Mounting Bracket Guide for further suggestions

- Custom mounting options available. Contact your local Server Technology representative

Cable Retention Devices for non-locking cords

- EZip

- Cable Sleeve

Drawings

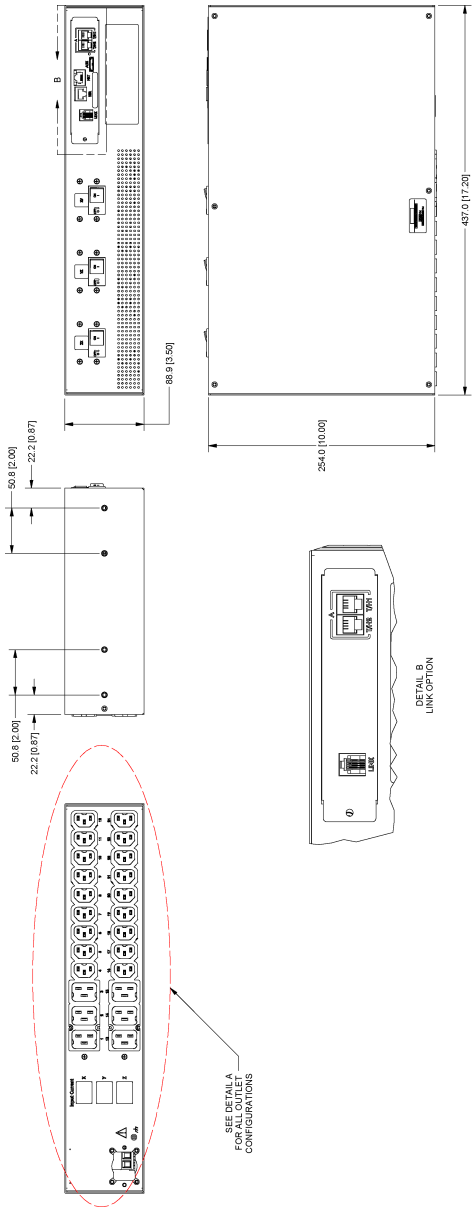

OPTIONAL OUTLET CONFIGURATIONS

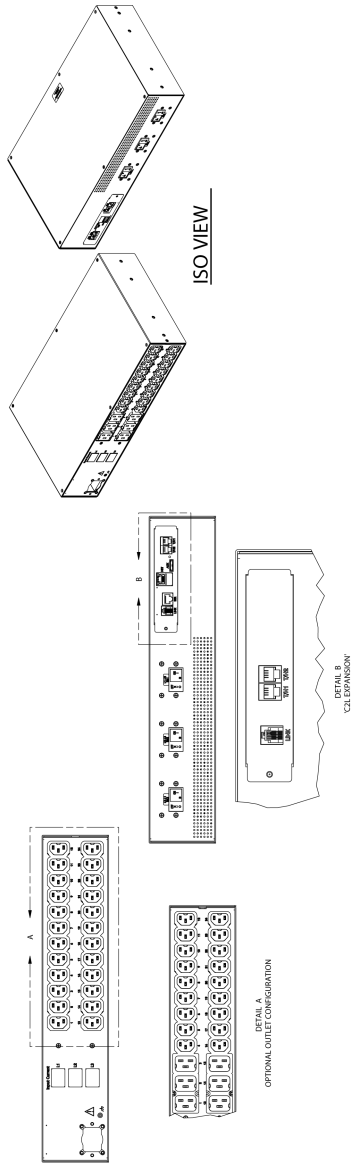
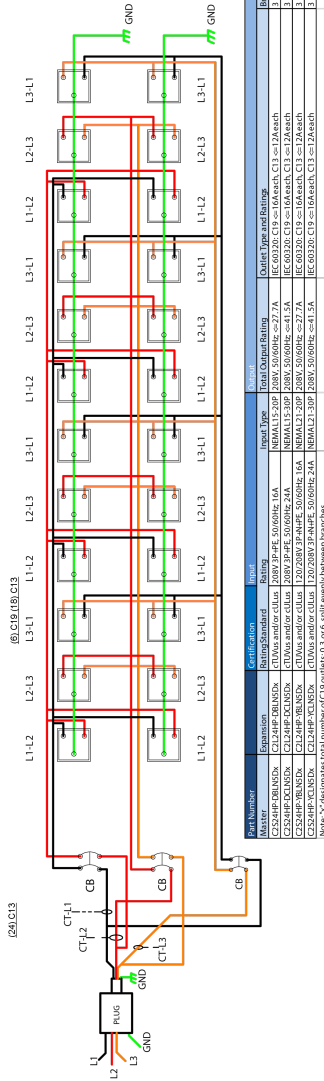
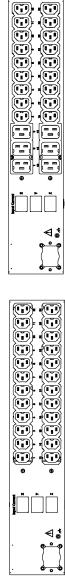

Additional Information

Warranty: Server Technology offers a standard 2-year limited parts & labor warranty. Extended support is available at the time of purchase. See the Support Options on the website, or contact your local Server Technology representative for more information.

Patents: Information on Server Technology patents is available on the website at: www.servertech.com/products/patents

"Global" models are typically for use in countries outside of North America. Contact your Server Technology representative for more information about which models are appropriate for your application.

Information in this document is current as of time of publishing. Contact your Server Technology representative for the most up-to-date information. This datasheet was generated on: 28-Mar-2025

Interested in learning more about how Server Technology can help you manage and distribute power in your datacenter?
Visit us online at: www.servertech.com/products/

To contact an expert in your region, go to www.servertech.com/about-us/office-locations for more information.

servertech.com ©2025 Legrand. All rights reserved. The industry-leading brands of Raritan, Server Technology, Starline, and Ortronics empower Legrand's Data, Power & Control to deliver innovative solutions for data centers, building networks, and facility infrastructures.