

48DCWC-08-2X100-B0NB (Primary)

48DCXC-08-2X100-B0NB (Link)

The Server Technology® -48VDC Switched PDU provides control of outlet power and per-outlet current measurement through the build-in Web and CLI interfaces as well as through SNMP. Temperature and humidity measurements can be provided via optional probes. The Switched "Primary" PDU can be connected to a Switched "Link" PDU to extend the network access to the redundant or secondary power feed.

Key Features



Network Monitoring

Gain access to valuable data through connections including HTTP(S), SSH, Telnet, SNMP, (S)FTP, SMTP, Syslog, LDAP(S), RS-232 serial, and more.



Star Multi-Linking

Provides the ability to link up to four power circuits using one IP address. Primary link provides backup power to network card.



Branch Circuit Protection

This PDU meets the UL and IEC 60950-1 requirement for branch circuit protection through the use of user specified TPC fuses.



Hot-Swap Network Card

Network access is ensured when power is lost to the primary unit with backup power provided by the primary link unit.

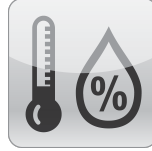

Temperature/Humidity Monitoring

Primary and Link units each support two external 10' (3m) T/H probes. Receive SNMP-based alerts and email notifications.

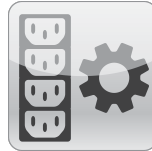

Outlet Control

On Switched rack PDUs, cycle power to individual outlets or groups of outlets to reboot servers. Or, power off unused receptacles.

Inputs

Input Voltage (V):	-48
Input Terminal:	(2) x 1/4-20 dual-studs on 5/8 in. centers (100A max)
Input Current (A):	200
Input Current Rated (A):	200
Input Power Capacity (kW):	9.6

Outputs

Terminals: (8) x #10 ring lug terminals (20A max) and (1) AUX #10 ring lug terminal (5A)

Branch Circuit Protection

User to select TPC fuses:

FUSE-TPC-10	10A Bussmann Telpower fuse
FUSE-TPC-15	15A Bussmann Telpower fuse
FUSE-TPC-20	20A Bussmann Telpower fuse
FUSE-TPC-25	25A Bussmann Telpower fuse
FUSE-TPC-30	30A Bussmann Telpower fuse
FUSE-TPC-40	40A Bussmann Telpower fuse
FUSE-TPC-50	50A Bussmann Telpower fuse
FUSE-TPC-60	60A Bussmann Telpower fuse
FUSE-TPC-75	75A Bussmann Telpower fuse
FUSE-TPC-100	100A Bussmann Telpower fuse
FUSE-TPC-125	125A Bussmann Telpower fuse

Physical

Dimensions: 3.5in tall x 17.0in wide x 17.6in deep [89mm x 432mm x 448mm]

Environmental

Operating Environment: 32°F to 122°F / 0°C to 50°C | 8%RH to 90%RH non-condensing | 6,500ft/2km elevation

Storage Environment: -40°F to 185°F / -40°C to 85°C | 8%RH to 90%RH non-condensing | 50,000ft/15km elevation

Quiescent / Unloaded Power Draw: < 10W for all configurations

Communications & Security

10/100 Mbps Ethernet (RJ-45 connector), RS-232 serial (RJ-45 connector)

Two (2) temperature/humidity sensor inputs (4P4C), Link port (RJ-12) - {also on Link PDU}

Web-browser GUI and command-line interface (CLI): HTTP/HTTPS, TLSv1.2, SSHv2, Telnet, SNMPv2c and v3 (GET, SET, Traps), IPv4 and IPv6, LDAPv3/LDAPS, TACACS+, RADIUS, FTP/SFTP

Certifications

North American:

Safety (TUV certified, cTUVus mark)

UL Std. 60950-1, 62368-1

CAN/CSA-C22.2 No. 60950-1, CAN/CSA-C22.2 No. 62368-1

EMC

FCC Part 15 Subpart B Sections 15.107 & 15.109, Class A

CAN ICES-003, Class A

Global:

Safety

EN 62368-1 (TUV certified, T-mark)

IEC 60950-1 incl. regional, national and harmonized differences (IECEE CB scheme)

IEC 62368-1 incl. regional, national and harmonized differences (IECEE CB scheme)

EMC

EN 55032 / IEC 55032 / CISPR 32

EN 55024 / CISPR 24

EN 55035 / IEC 55035 / CISPR 35

EN 61000-3-2 / IEC 61000-3-2

EN 61000-3-3 / IEC 61000-3-3

RoHS, European Hazardous Materials Directive, 2011/65/EU

WEEE Compliant

CE Mark

UK Legislation

RoHS, Electrical Equipment (Safety) and Electromagnetic Compatibility

NEBS Level 3

GR-1089-Core: Sections 1-4, 7, 9, and 10

GR-63-Core: Sections 4.1, 4.2, 4.3, 4.4, 4.5, and 4.7

Measurement Accuracy

Output Measurement Specifications

20A Outputs:

Minimum current required: 0.20A

Maximum current measured: 20.5A

Displayed resolution: 0.01A

Accuracy: $\pm 5.0\%$

Optional Accessories

EMTH-2-10 Combination Temperature/Humidity Probe, 10ft (3m)

EMCU-1-1C Environmental Monitor adding:

- Two (2) EMTH-2-10 temperature/humidity ports (one probe included)
- One (1) EMWS-1-1 water sensor port (probe sold separately)
- Four (4) dry contact (NO/NC) monitoring points
- One (1) 8-bit analog-to-digital converter (0 to 5VDC)

KIT-SUS-01 StartUp Stick™ for rapid configuration Mounting Brackets

- mounting brackets included
- See the Mounting Bracket Guide for further suggestions
- Custom mounting options available. Contact your local Server Technology representative

Drawings

NOTES:

1. DIMENSIONS ARE IN MILLIMETERS AND [] ARE IN INCHES.
2. MOUNTING BRACKETS CAN BE MOUNTED IN SEVERAL DIFFERENT POSITIONS. SEE FIGURE 1 AND 2.
3. DIMENSIONS ARE NOMINAL. INFORMATION SUBJECT TO CHANGE WITHOUT NOTICE.

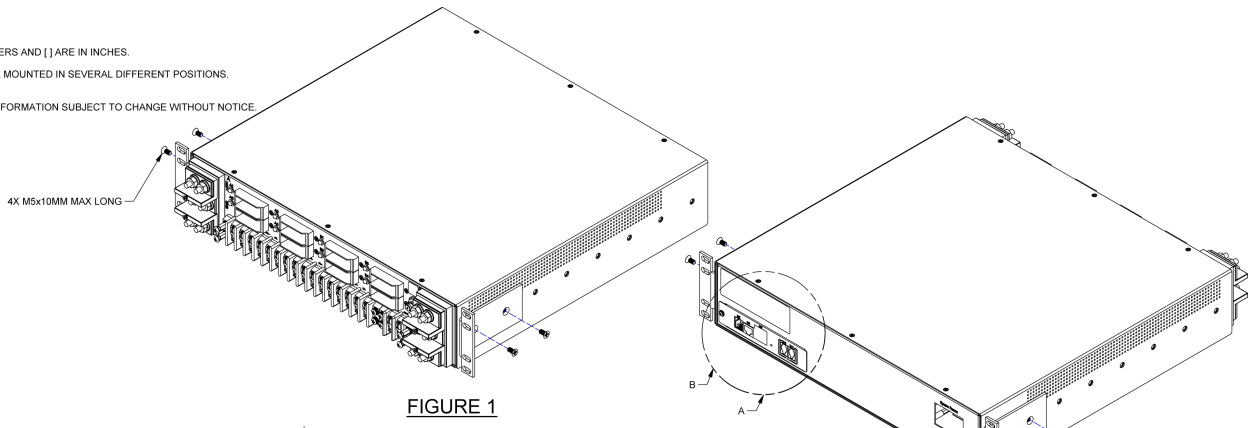
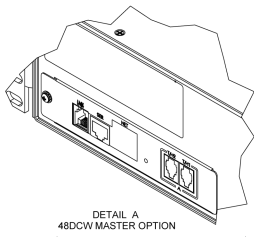
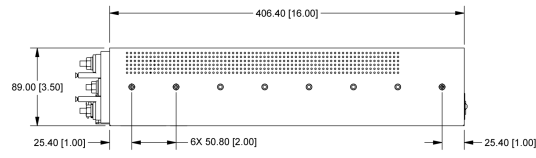
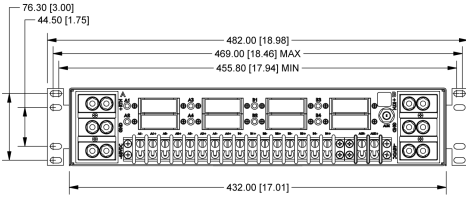
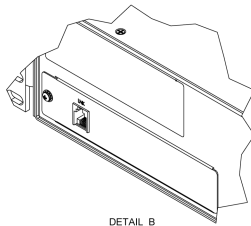

FIGURE 1

FIGURE 2



DETAIL A
48DCW MASTER OPTION



DETAIL B
48DCX LINK OPTION

Additional Information

Warranty: Server Technology offers a standard 2-year limited parts & labor warranty. Extended support is available at the time of purchase. See the Support Options on the website, or contact your local Server Technology representative for more information.

Patents: Information on Server Technology patents is available on the website at: www.servertech.com/products/patents

"Global" models are typically for use in countries outside of North America. Contact your Server Technology representative for more information about which models are appropriate for your application.

Information in this document is current as of time of publishing. Contact your Server Technology representative for the most up-to-date information. This datasheet was generated on: 1-Dec-2021

Interested in learning more about how Server Technology can help you manage and distribute power in your datacenter?
Visit us online at: www.servertech.com/products/

North America Headquarters

1040 Sandhill Road
Reno, Nevada 89521
1-775-284-2000 Tel
1-800-835-1515 Toll Free
1-775-284-2065 Fax
sales@servertech.com
www.servertech.com
www.servertechblog.com

EMEA Region

4th Floor, 25-26 Lime
Street
London, EC3M 7HR
United Kingdom
+44 20 7090 1390 Tel
salesint@servertech.com

Singapore

17 Neythal Road
Singapore, 628582
Singapore
+65 6817 9017 Tel
salesint@servertech.com

India

210, Block B, Vipul Square
Sushant Lok 1
Gurgaon, Haryana 122002
India
+91 124 410 7881 Tel
+91 124 410 7880 Fax
salesint@servertech.com

**Server
Technology**[®]
A brand of  **legrand**

©2021 Server Technology, Inc. HDOT, PIPS, POPS, CDU, Sentry, Server Technology, Power Pivot, EZip, StartUp Stick and PRO2 are U.S. registered trademarks of Server Technology, Inc. All others are registered trademarks are trademarks of their respective owners. Information is subject to change without notice. Server Technology offers a wider range of products for North America and Global Markets; for more information visit www.servertech.com.